

# SECUENCIA DE CUATRO EVENTOS

Nombre: \_\_\_\_\_ Fecha: \_\_\_\_\_

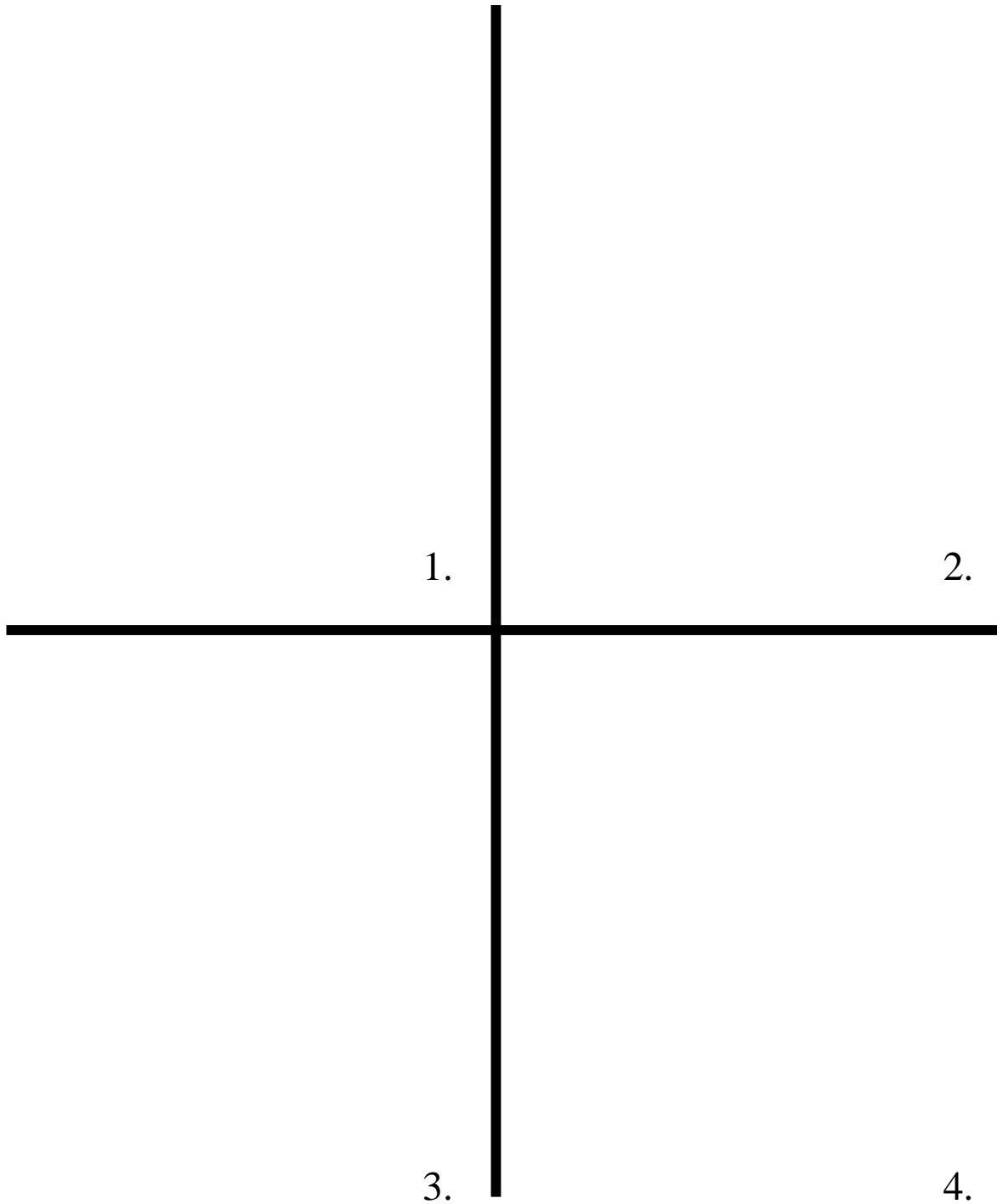

# SECUENCIA DE SEIS EVENTOS

Nombre: \_\_\_\_\_ Fecha: \_\_\_\_\_

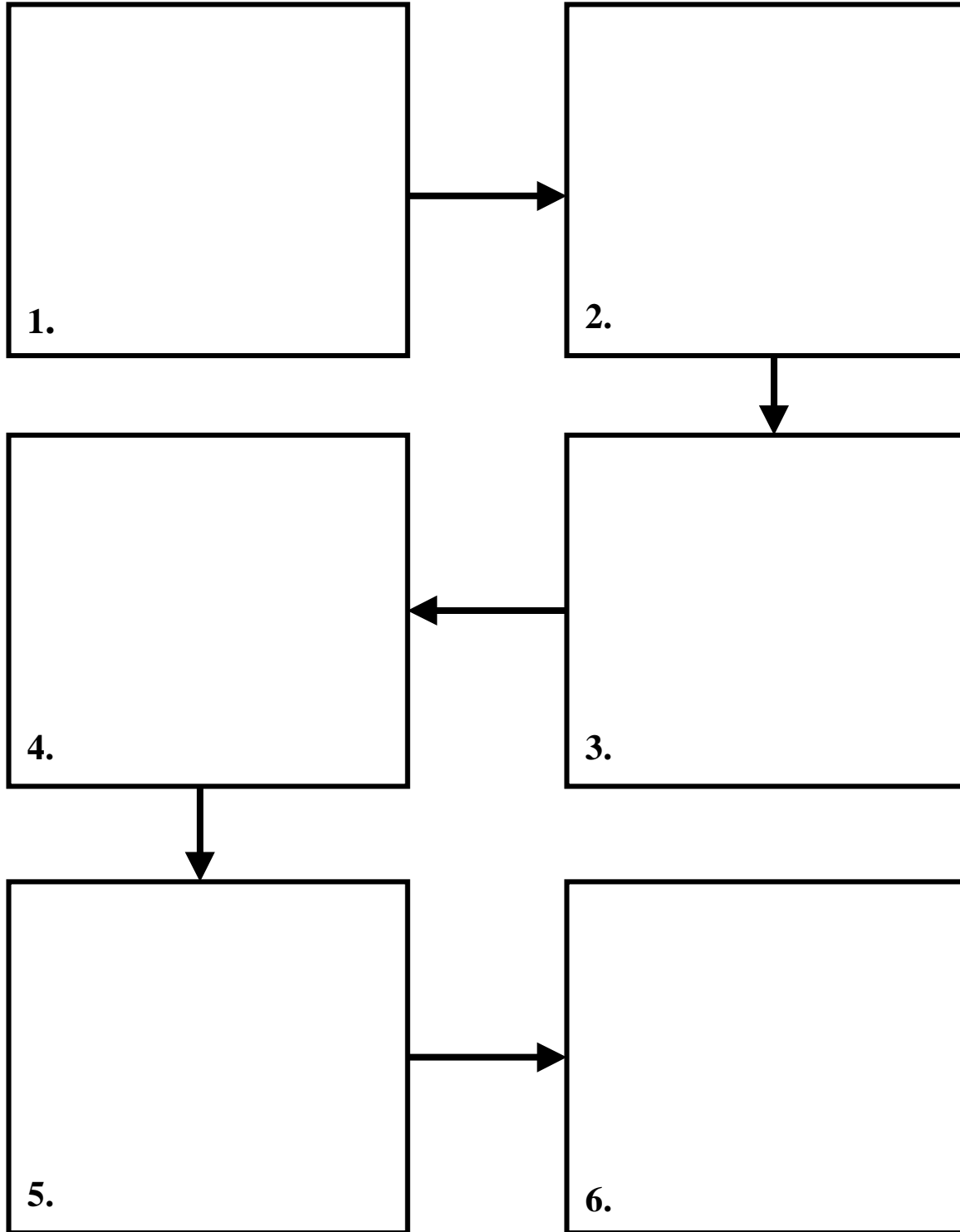

Nombre: \_\_\_\_\_ Fecha: \_\_\_\_\_

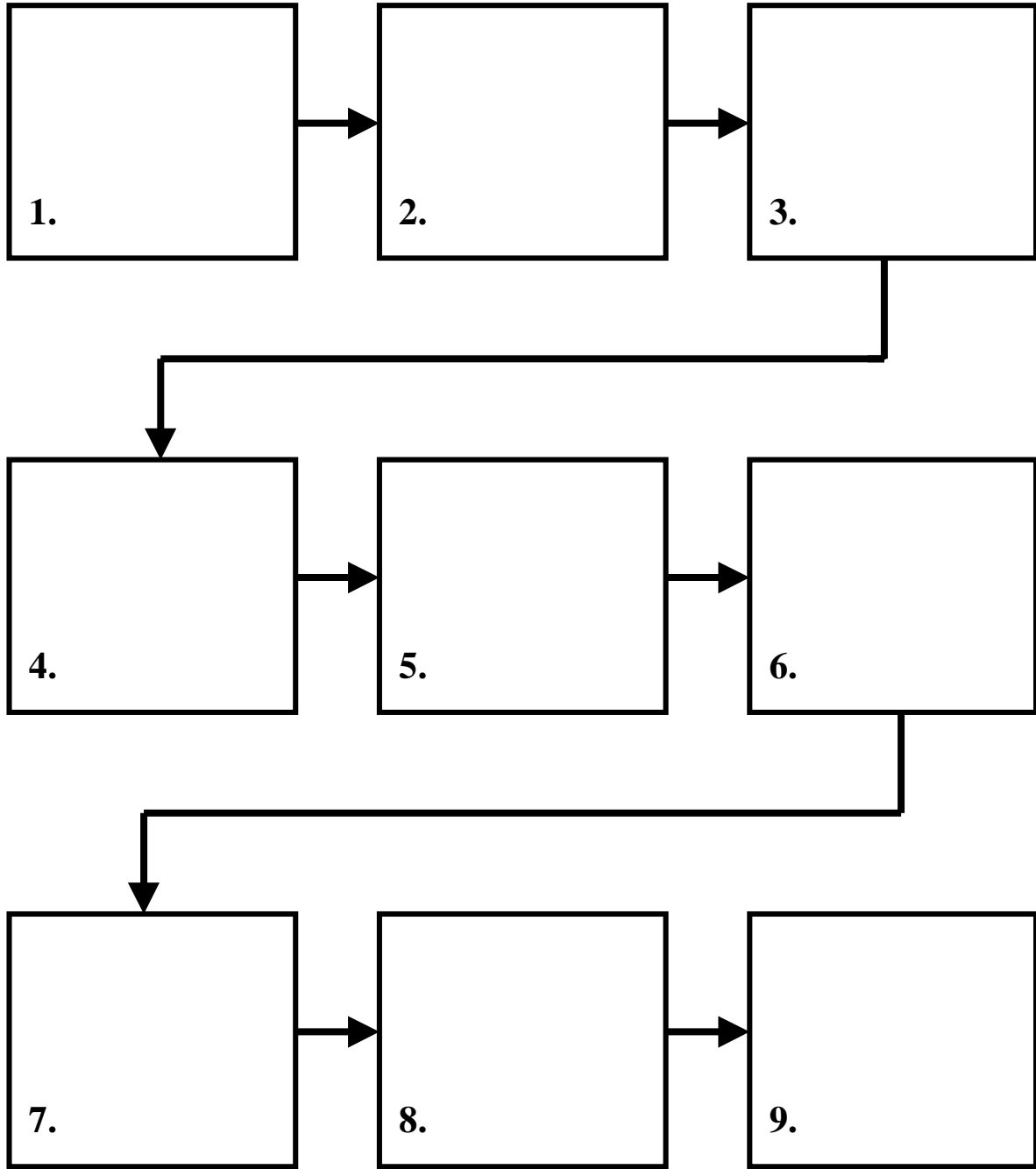

# PASOS

Nombre \_\_\_\_\_ Fecha: \_\_\_\_\_

A. \_\_\_\_\_

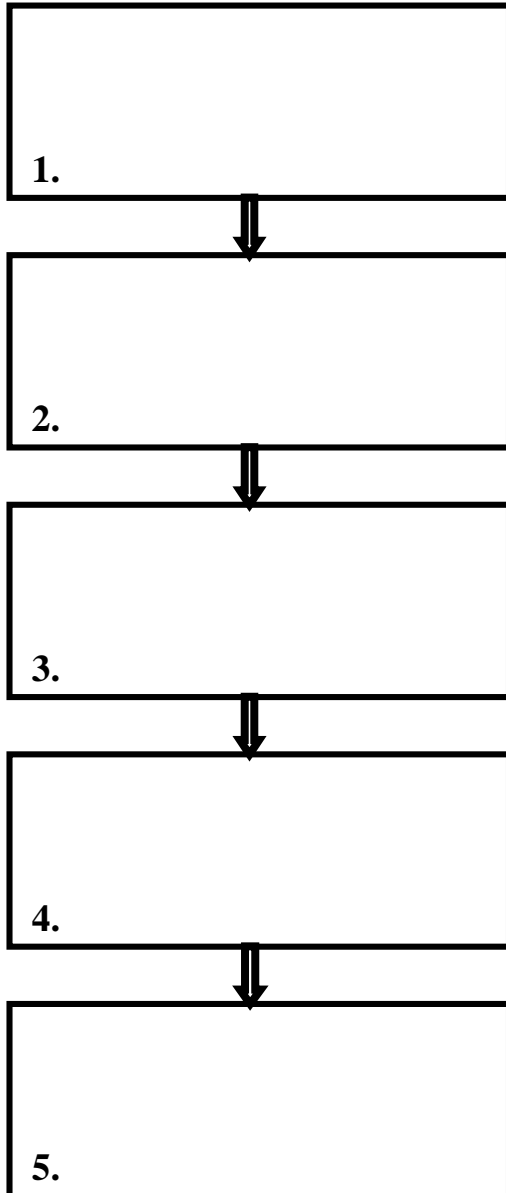

B. \_\_\_\_\_

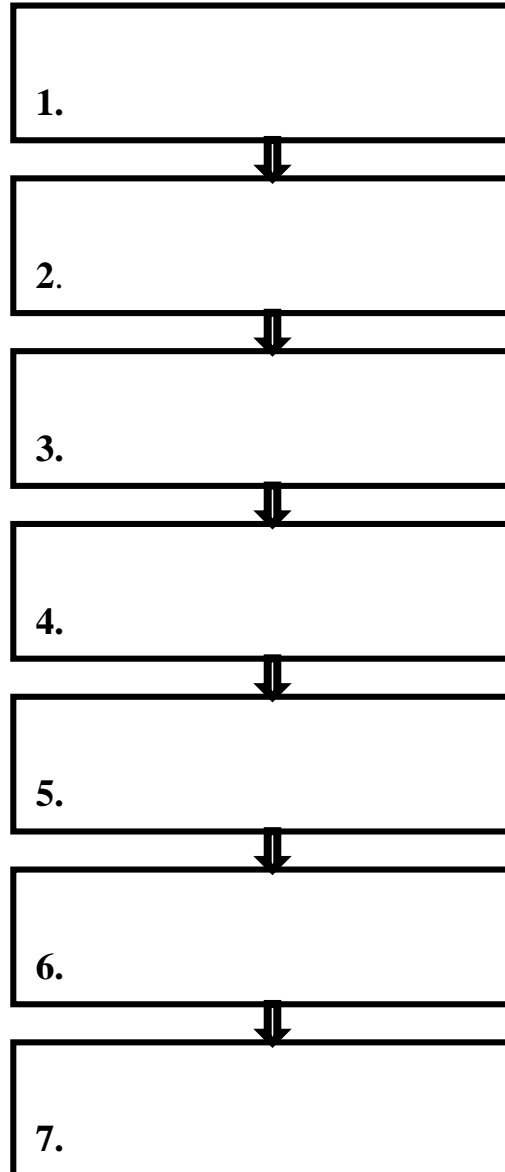

# SECUENCIA EN CÍRCULO

Nombre: \_\_\_\_\_ Fecha: \_\_\_\_\_

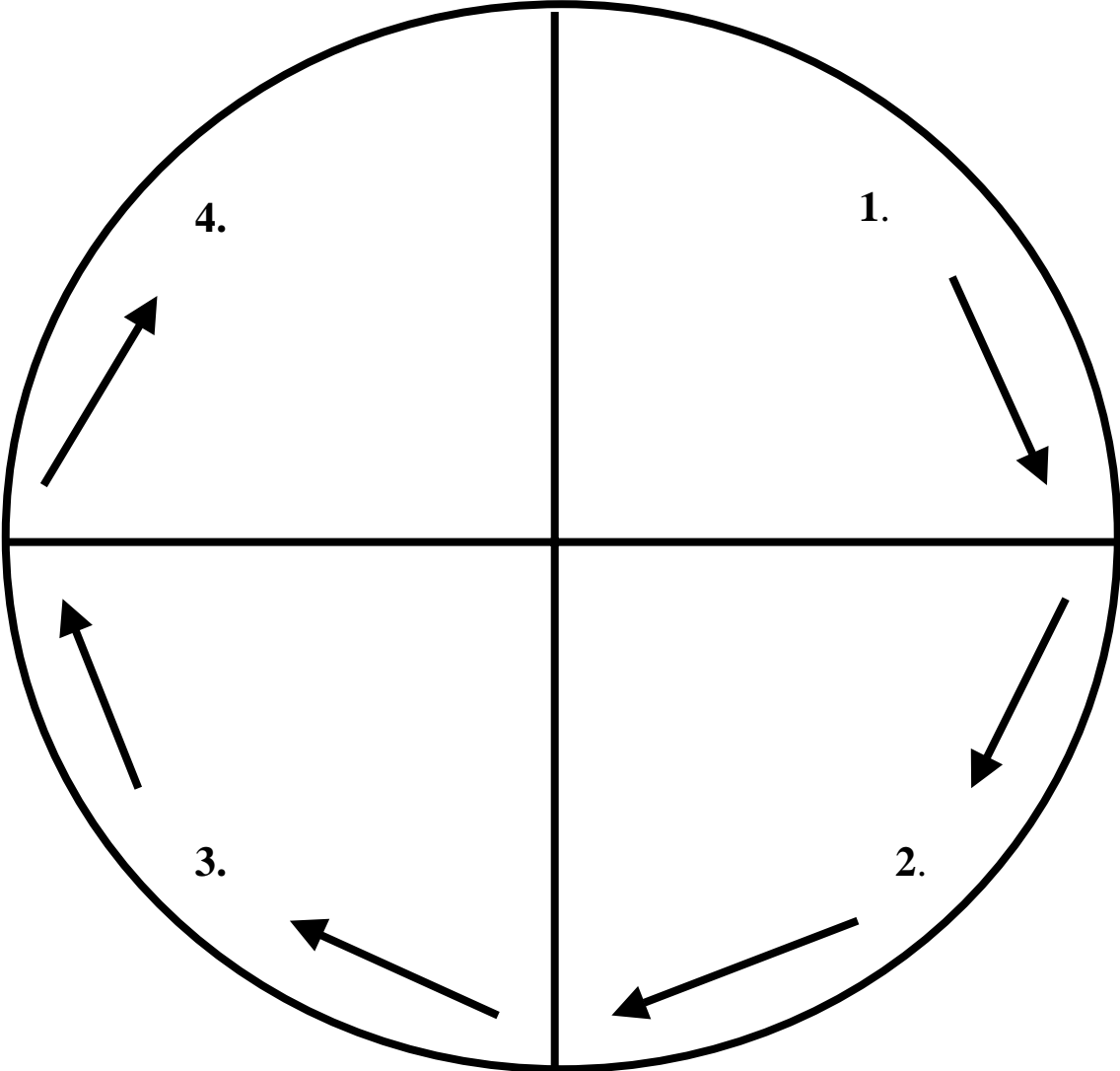

# LA RUEDA

Nombre: \_\_\_\_\_ Fecha: \_\_\_\_\_

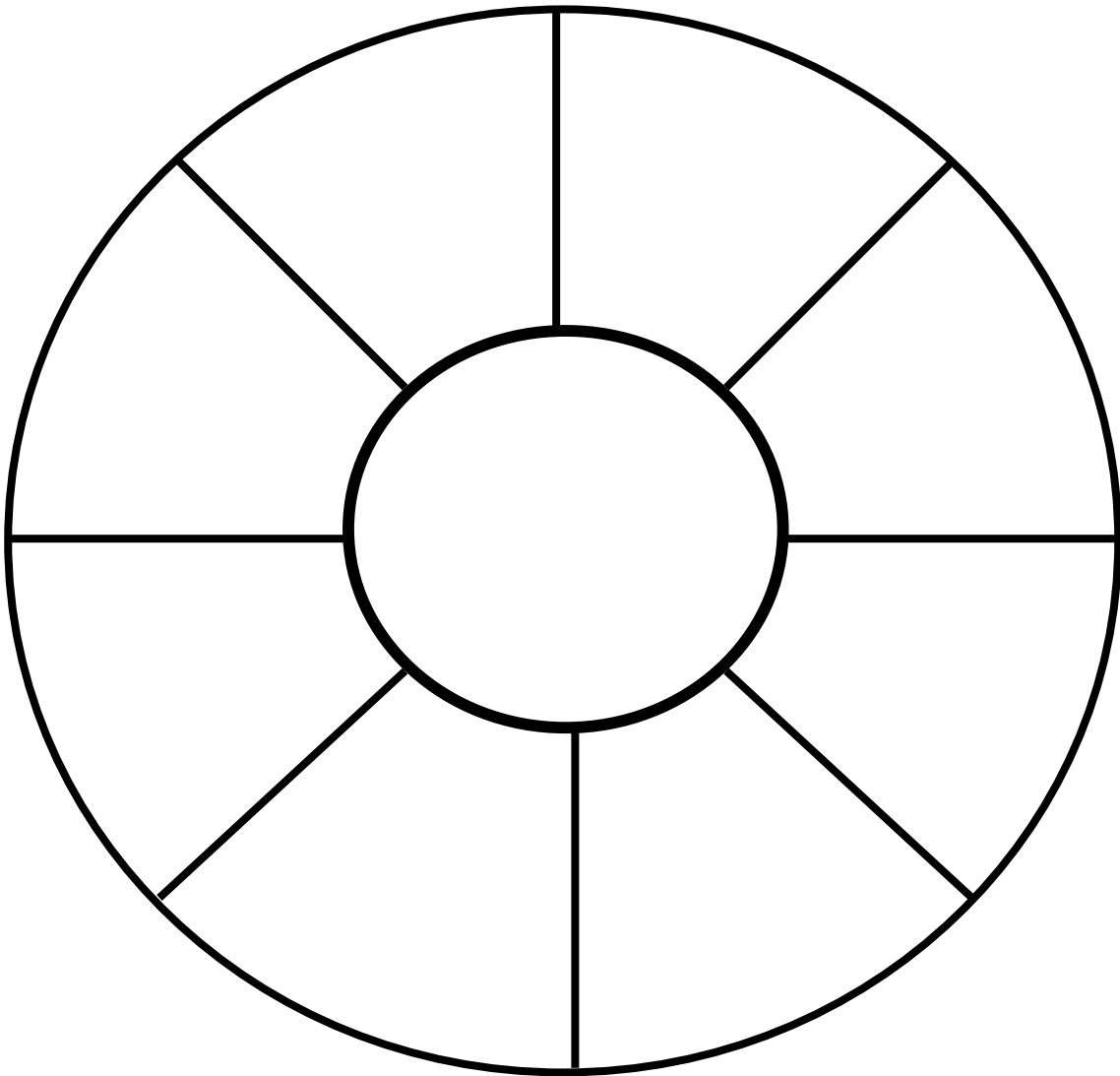

# CICLO EN GRÁFICA

Nombre: \_\_\_\_\_ Fecha: \_\_\_\_\_

**Título:** \_\_\_\_\_

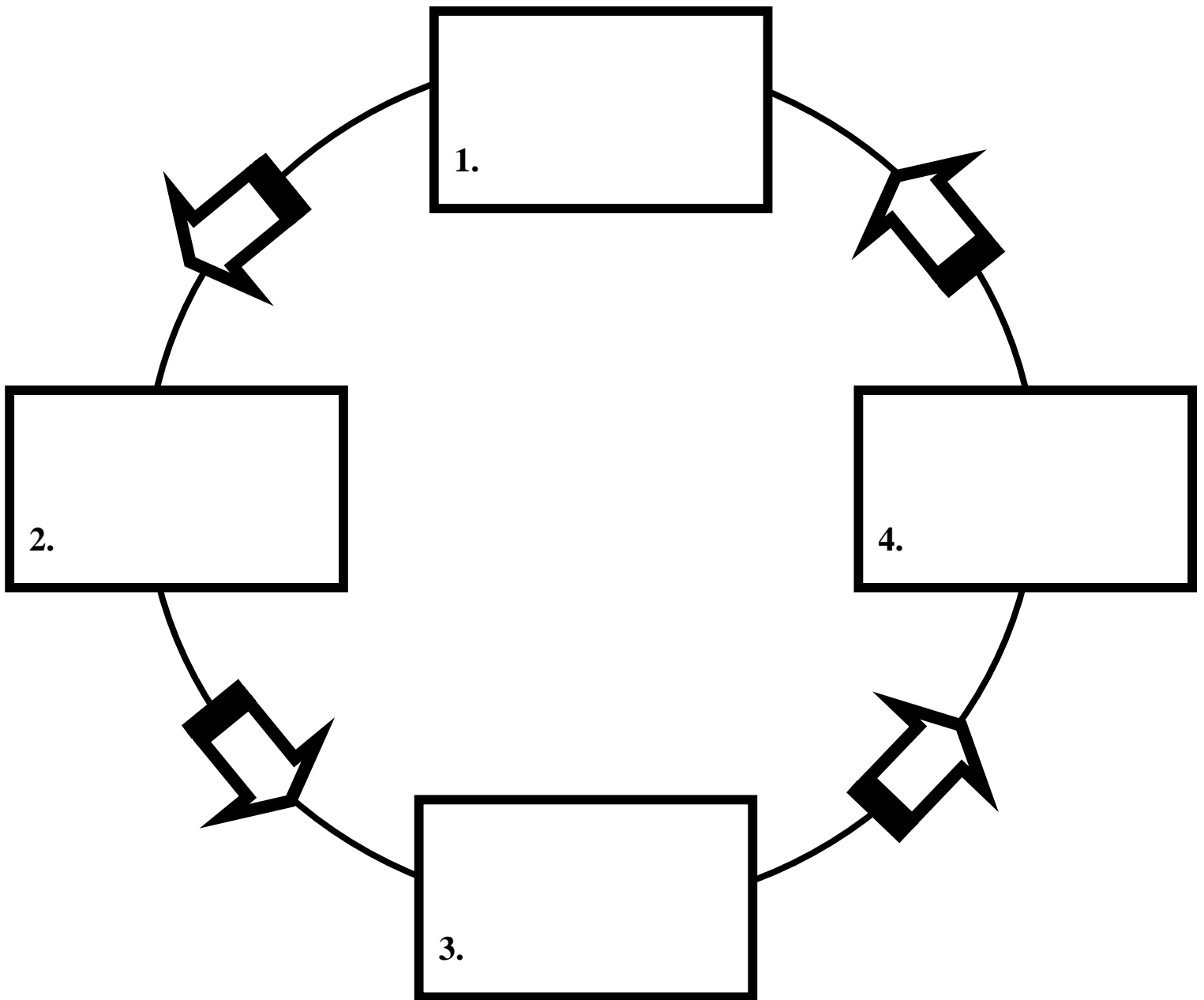

GO.30.7

# RESUMEN DE UN CUADRO DE UNA HISTORIA

Nombre: \_\_\_\_\_ Fecha: \_\_\_\_\_

**Título de la Historia** \_\_\_\_\_

**En esta Historia, el problema comienza cuando** \_\_\_\_\_

---

---

---

**Luego,** \_\_\_\_\_

---

---

---

**Entonces,** \_\_\_\_\_

---

---

---

**Próximo,** \_\_\_\_\_

---

---

---

**El problema se resuelve cuando** \_\_\_\_\_

---

---

---

**La Historia termina** \_\_\_\_\_

---

---

---



# CADENA DE EVENTOS

Nombre: \_\_\_\_\_ Fecha: \_\_\_\_\_

Comienzo

<b>Evento:</b>
<b>Tiempo:</b>
<b>Notas:</b>



<b>Evento:</b>
<b>Tiempo:</b>
<b>Notas:</b>



<b>Evento:</b>
<b>Tiempo:</b>
<b>Notas:</b>



<b>Evento:</b>
<b>Tiempo:</b>
<b>Notas:</b>



<b>Evento:</b>
<b>Tiempo:</b>
<b>Notas:</b>

Final

# SECUENCIA

Nombre: \_\_\_\_\_ Fecha: \_\_\_\_\_

Capítulo \_\_\_\_\_

Encuentra 6 eventos principales en este capítulo y anótalos.

1.



2.



3.



4.



5.



6.



# TIEMPO LINEAR PARA \_\_\_\_\_

Nombre: \_\_\_\_\_ Fecha: \_\_\_\_\_

1.	2.	3.	4.
----	----	----	----

**TÍTULO:** \_\_\_\_\_

**Nombre:** \_\_\_\_\_ **Fecha:** \_\_\_\_\_

<b>Verano</b>	<b>Otoño</b>
<b>Invierno</b>	<b>Primavera</b>

**TÍTULO:** \_\_\_\_\_

**Nombre:** \_\_\_\_\_ **Fecha:** \_\_\_\_\_

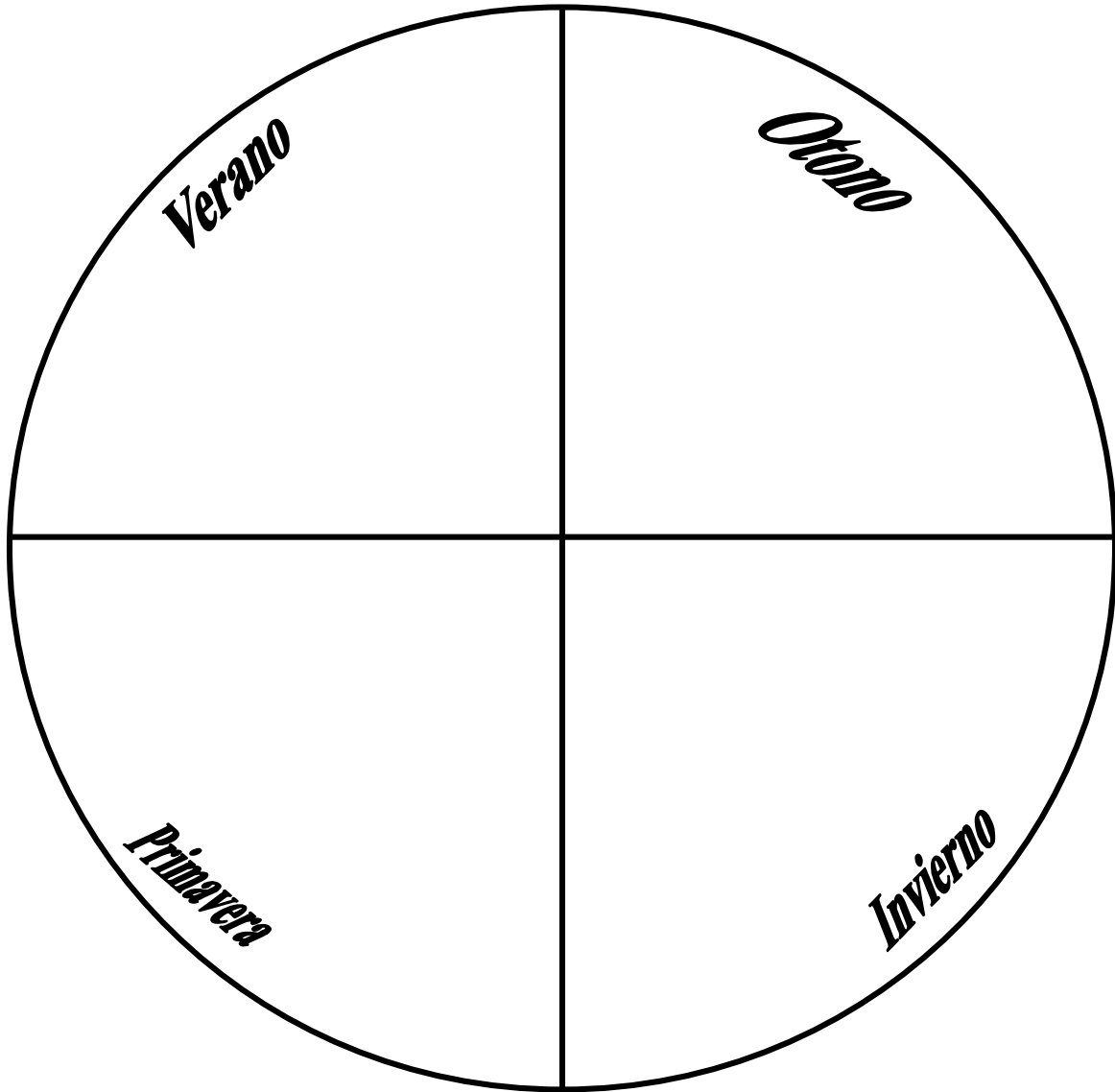

GO.30.13

**DIRECCIONES DE COMO HACER UN-UNA**\_\_\_\_\_

**Por:** \_\_\_\_\_

**Primero,**

**Segundo,**

**Tercero,**

**Entonces,**

**Por último,**

**TEMA:** \_\_\_\_\_

**Nombre:** \_\_\_\_\_ **Fecha:** \_\_\_\_\_

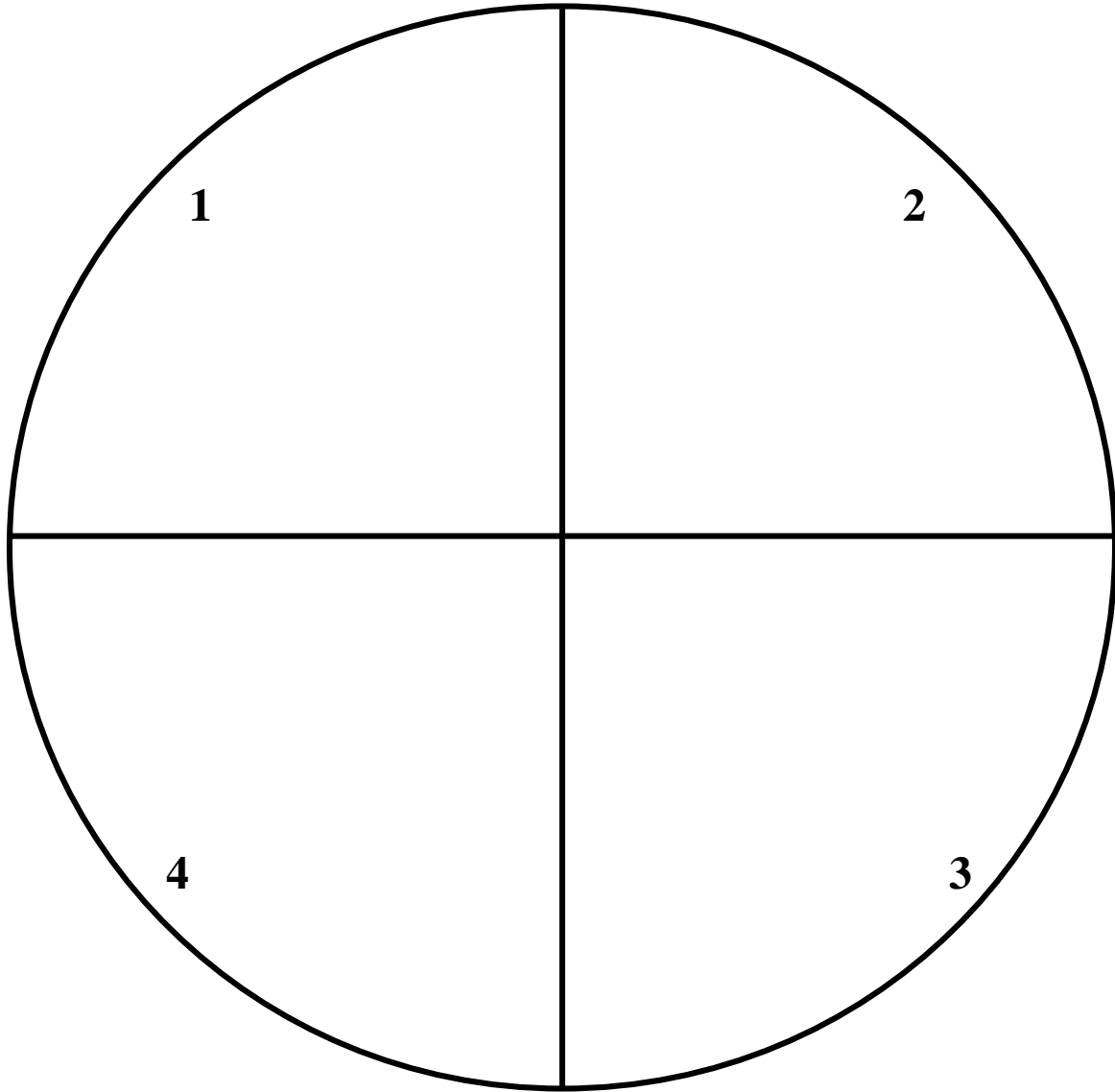

**GO.30.15**

**TEMA:** \_\_\_\_\_

**Nombre:** \_\_\_\_\_ **Fecha:** \_\_\_\_\_

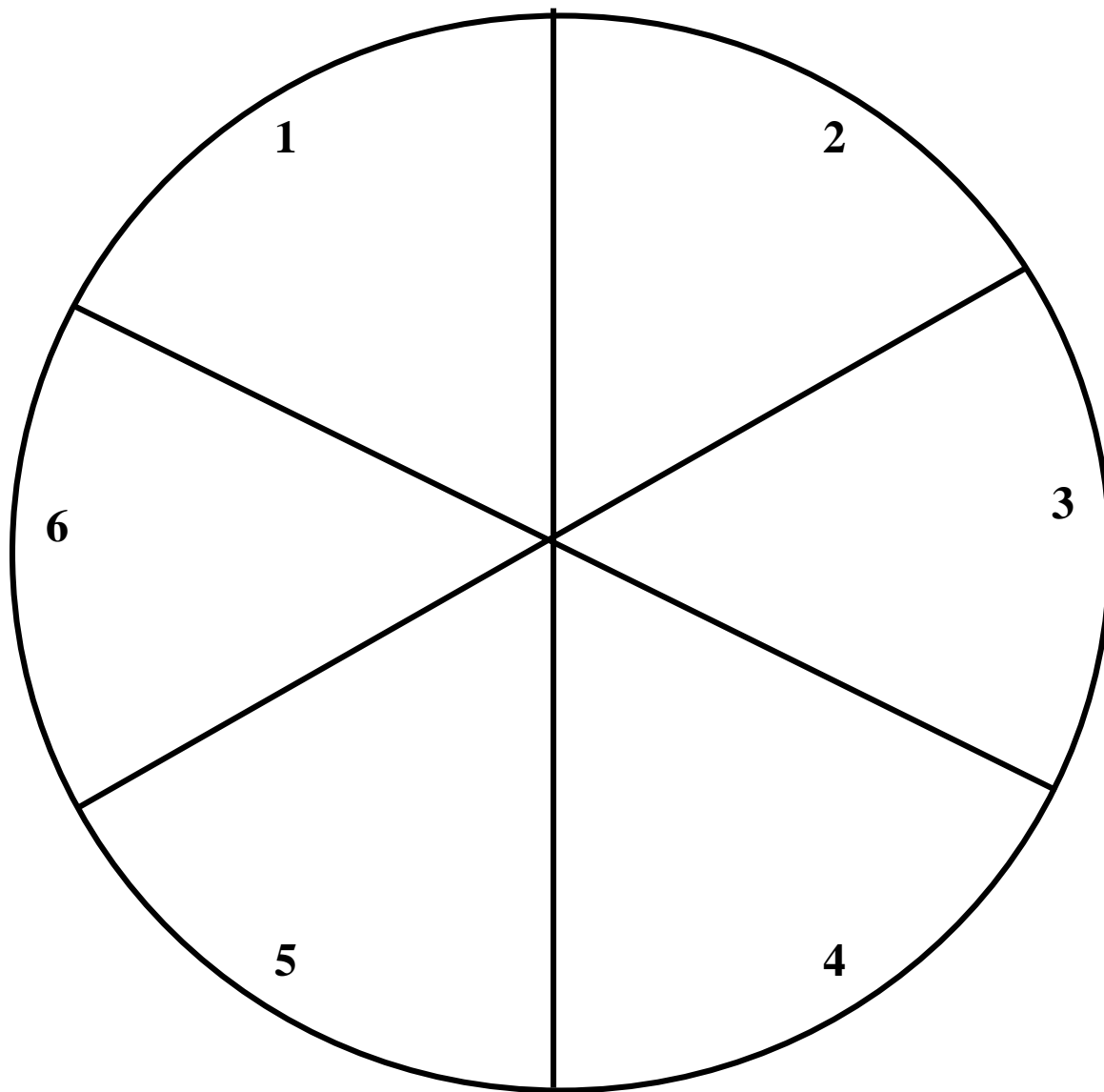

**GO.30.16**



**TEMA:** \_\_\_\_\_

**Nombre:** \_\_\_\_\_ **Fecha:** \_\_\_\_\_

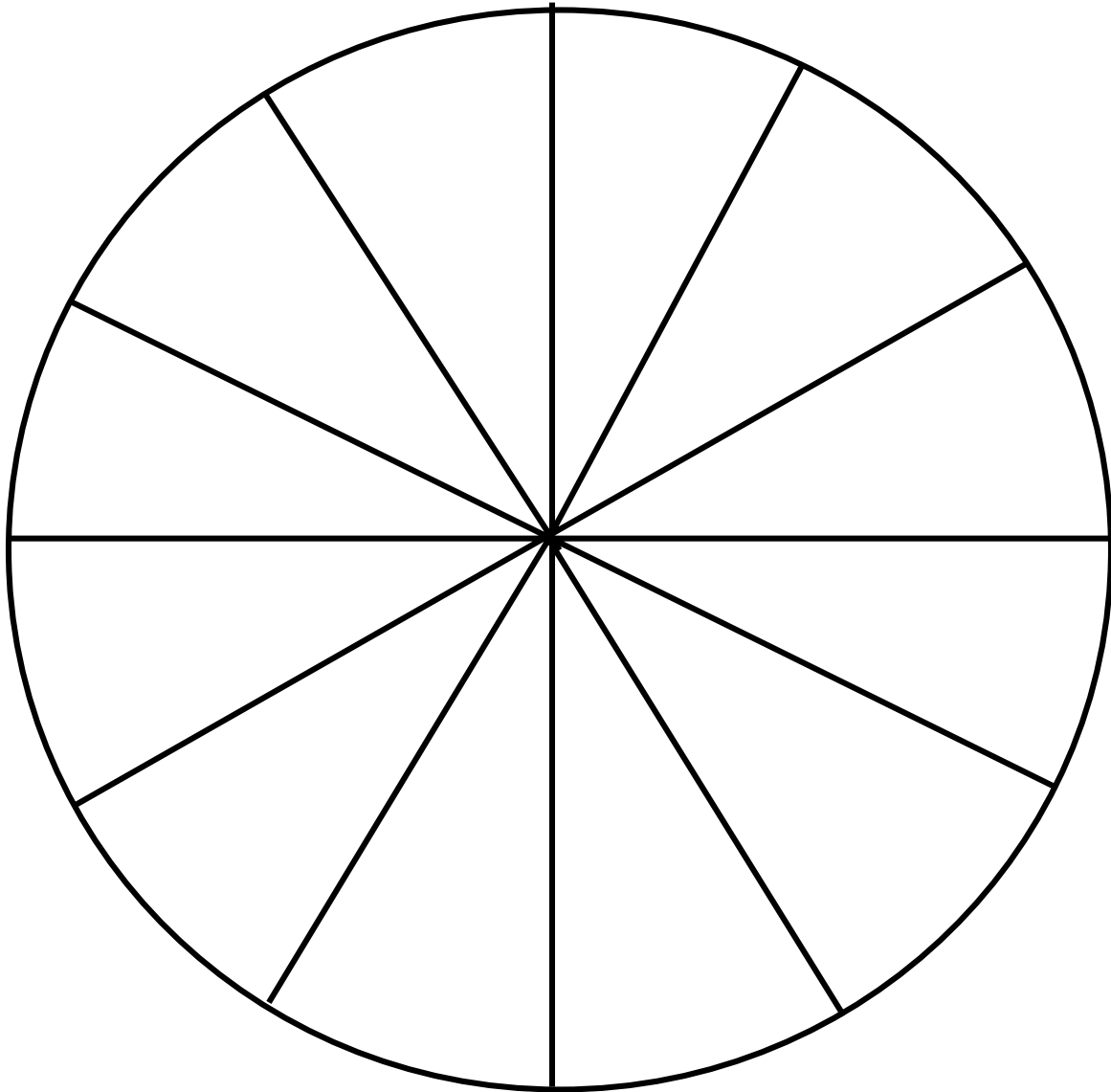

**GO.30.17**

**TEMA:** \_\_\_\_\_

**Nombre:** \_\_\_\_\_ **Fecha:** \_\_\_\_\_

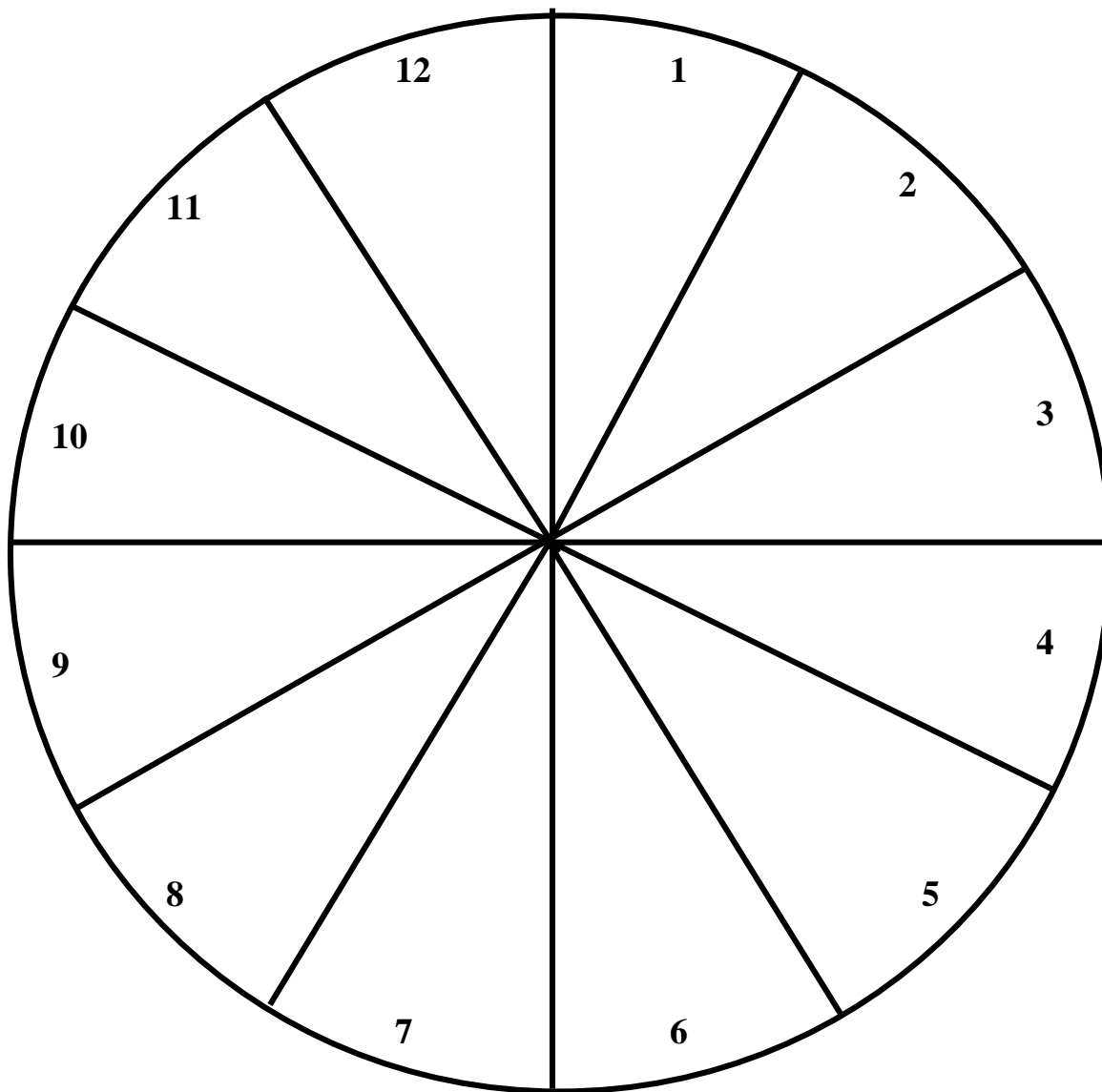

**GO.30.18**

**TÍTULO:** \_\_\_\_\_

**Nombre:** \_\_\_\_\_ **Fecha:** \_\_\_\_\_

**A.**

**B.**

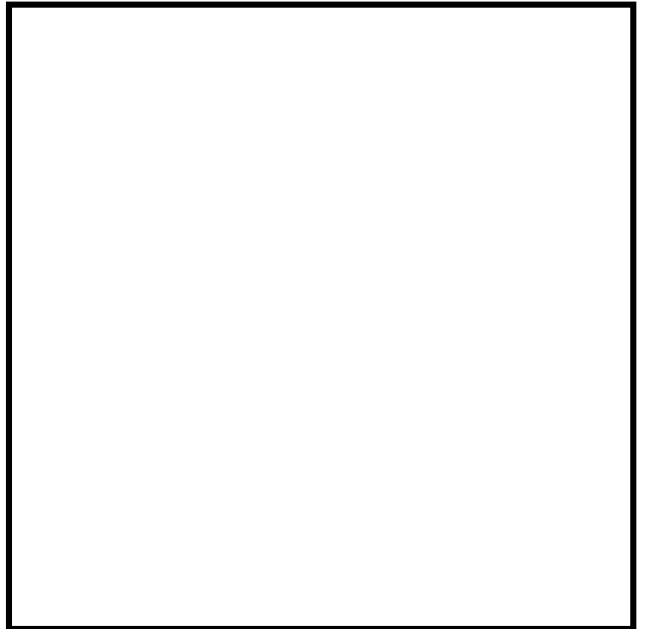
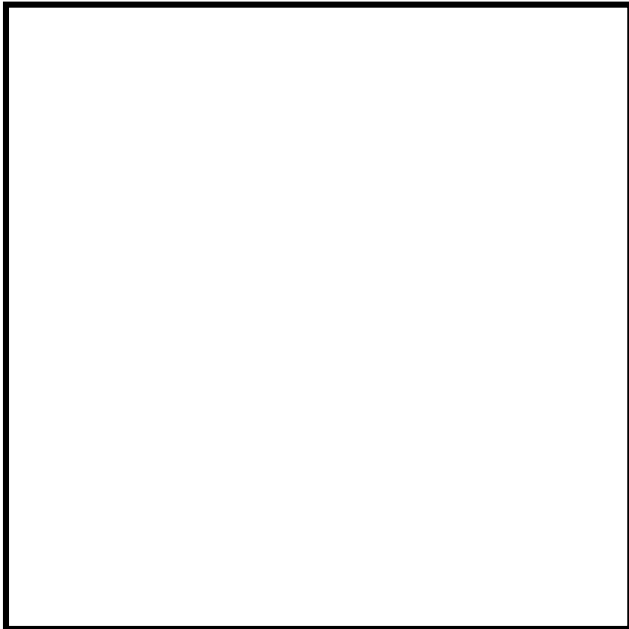

---

---

---

---

---

---

---

---

---

---

